

## PRESSURE REDUCING VALVES

### PRESSURE REDUCING VALVES FOR DOMESTIC SERVICES

Sizes: 1/2" - 3/4" - 1" - 1 1/4" - 1 1/2" - 2"

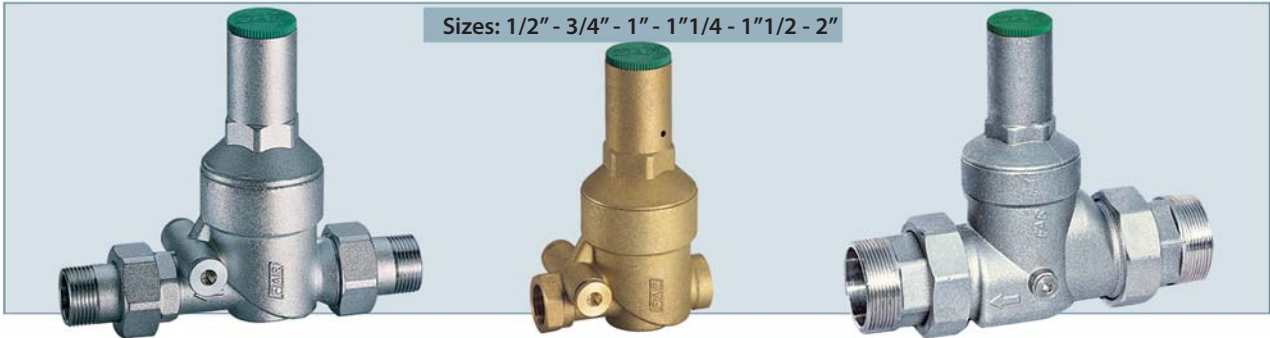

### PRESSURE REDUCING VALVES FOR DOMESTIC SERVICES – compact line

Sizes: 1/2" - 3/4"



## 1. DESCRIPTION

The main purpose of these reducing valves is to maintain constant pressure in the system, even when the upstream pressure varies widely. Such variations usually occur during the night, or at the weekend, when the use of water decreases. Maintaining constant system pressure avoids leaks and/or malfunction of taps, dishwashers, washing machines etc.

The schematic below refers to the UNI EN 1567:2002 standard: "Valves for buildings - Water pressure reducing valves and mixed pressure reducing valves - Requirements and tests methods". In the diagram the inner dotted line represents the pressure variations obtained during laboratory tests.

The influence test requires that any increase in inlet pressure

must not affect the outlet pressure. The diagram shows that the FAR pressure reducing valve is well within the curve demanded by the European standard. The limit curves are represented by an area contained between 2.8 and 3.2 bar for the downstream pressure (up to 10bar for upstream pressure) and by the cone up to 2.2 and 3.8 bar, at an upstream pressure of 16 bar. In other words, if water pressure rises, the set pressure remains constant.

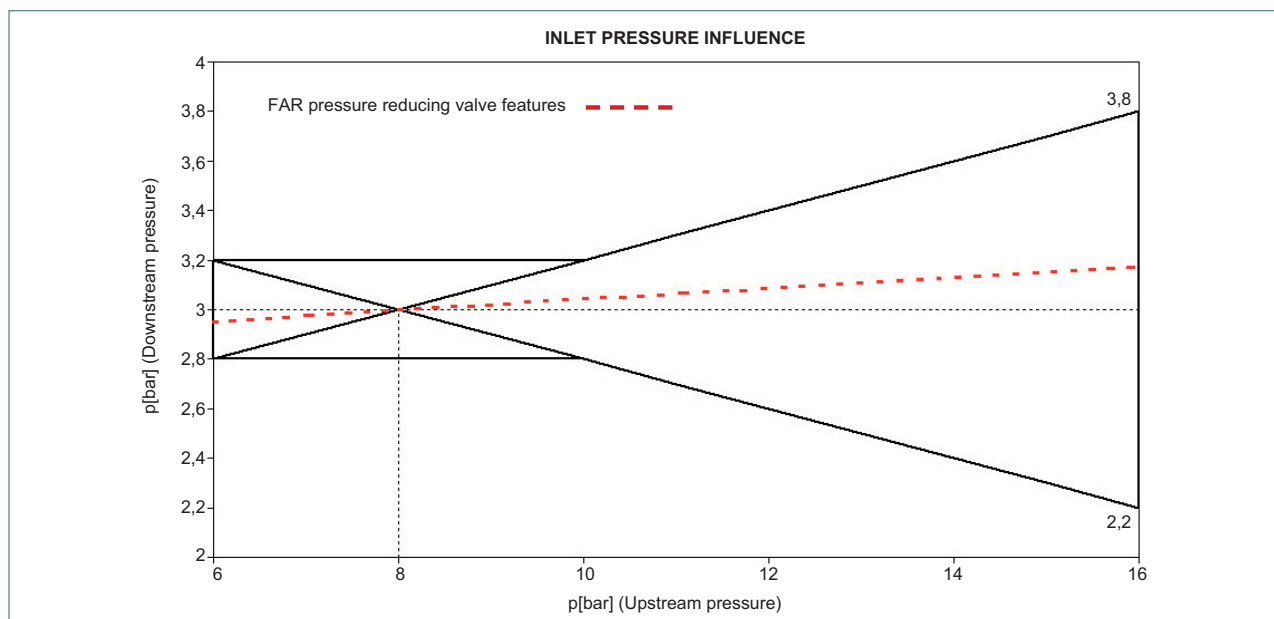

## 2. FUNCTION

The set pressure is kept constant by means of a membrane, which balances the opening force applied by the pressure calibration spring. The special shape of the stem and the internal profile of the cartridge ensure that fluid flows smoothly and quietly through the valve, without potentially damaging turbulence. The stem seal

inside the cartridge has been designed to operate with high upstream pressures. It comprises an O-ring toroidal gasket, enclosed between two Seger washers made of a special material with an antiextrusion function. A connection for a pressure gauge is located near the outlet of the pressure reducing valve.

When taps are closed, the pressure of the fluid stream on the membrane is equal to the force of the calibration spring. In this way the shutter rises and closes the flow pathway.

When the user turns on a tap the water pressure acting on the membrane is reduced, allowing the spring to open and fluid to flow.

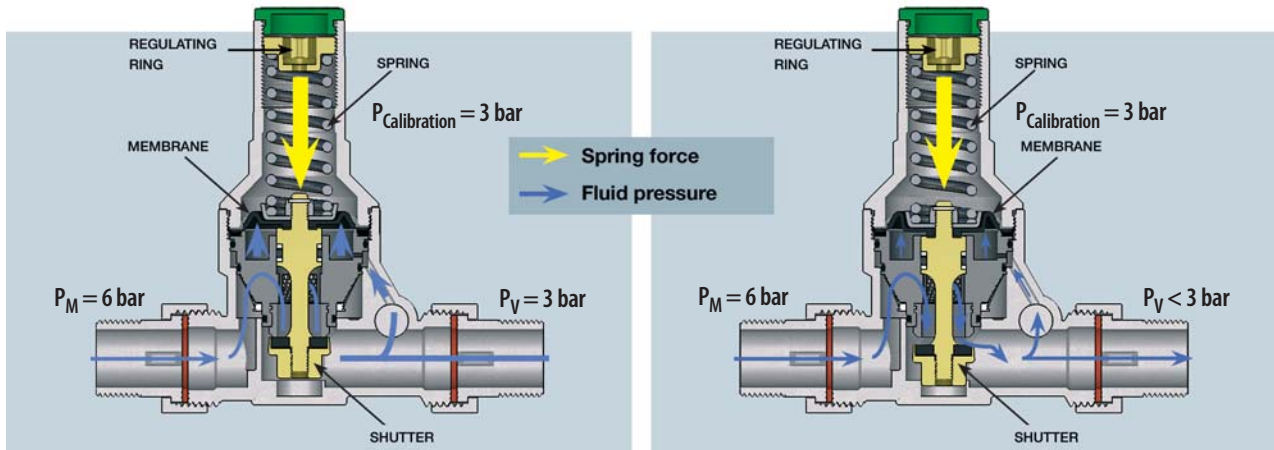

## 3. INSTALLATION

When FAR reducing valves are installed in a new application, it is essential that the system is clean and free of debris which might damage the cartridge and the valve housing. The pressure reducing valve is normally located between two shut off points, one downstream and one upstream. These are useful for downstream pressure calibration and for regular, periodic maintenance.



It is recommended that a strainer should always be located upstream of the reducing valve (even though a small strainer is already built in to the cartridge) in order to increase the efficiency and life of the reducing valve and to ensure cleaner water in the system.



Cleaning of the pipework is recommended before installation.

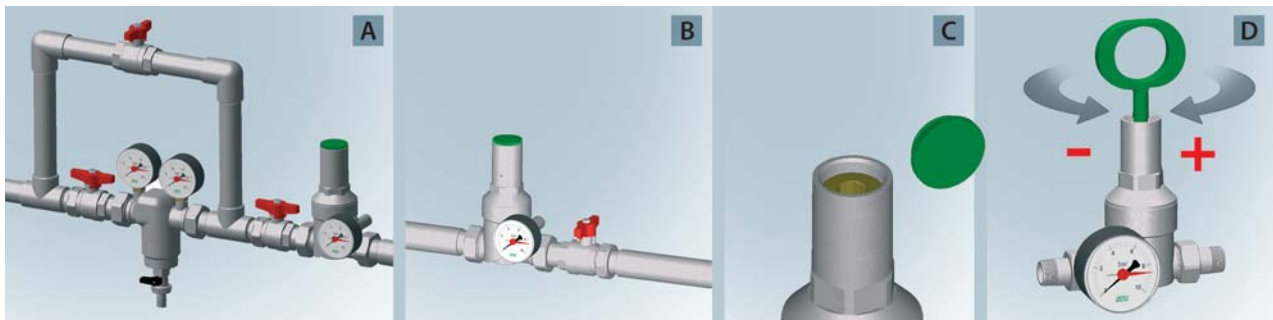

Calibration of the downstream pressure on the reducing valve is made by increasing, or decreasing the compression of the spring located inside the cap in the upper part of the reducing valve. In order to set the pressure value, once the reducing valve is installed, it is essential to:

- Close the shut off valve downstream of the reducing valve (Fig. B)
- Unscrew and remove the protective plug (Fig. C)
- Using the Allen wrench supplied, screw the spring nut in a clockwise direction; the spring is thus compressed and the value of the calibrated pressure increases (unscrewing counter-clockwise causes both spring and calibration pressure to decrease). (Fig. D)

In order to make sure that calibration has taken place, it is recommended that the shut off valve downstream of the reducing valve be opened and closed - NB these operations must be carried out slowly, without risking damage to system components from water hammer. Now screw the protective cap back in position. Once these operations have been carried out, the reducing valve is calibrated.

FAR reducing valves will automatically compensate for changing pressures in the system so that any sudden pressure surge in the water flow will not affect the setting. The limits of variation in downstream pressure will depend on any rise or reduction in the pressure upstream of the reducing valve.

## 4. MAINTENANCE

In a domestic system with no strainer located immediately after the meter at the water inlet, particles of calcareous substances, mineral salts, etc can pass through and deposit on the filter, which is incorporated into the cartridge inside the pressure reducing valve. Deposits formed in this way can decrease water flow, thus causing pressure flow problems. For this reason, although maintenance is simple, it should be carried

out by a qualified plumber. FAR 1/2", 3/4", 1" and 1 1/4" pressure reducers have a system for extracting the internal cartridge with no requirement for special tools that might damage key components of the valve. Extraction of the cartridge can be carried out without the need to disconnect the reducing valve from the pipework. In order to do this first close the shut off valves located before and after the reducer and then:

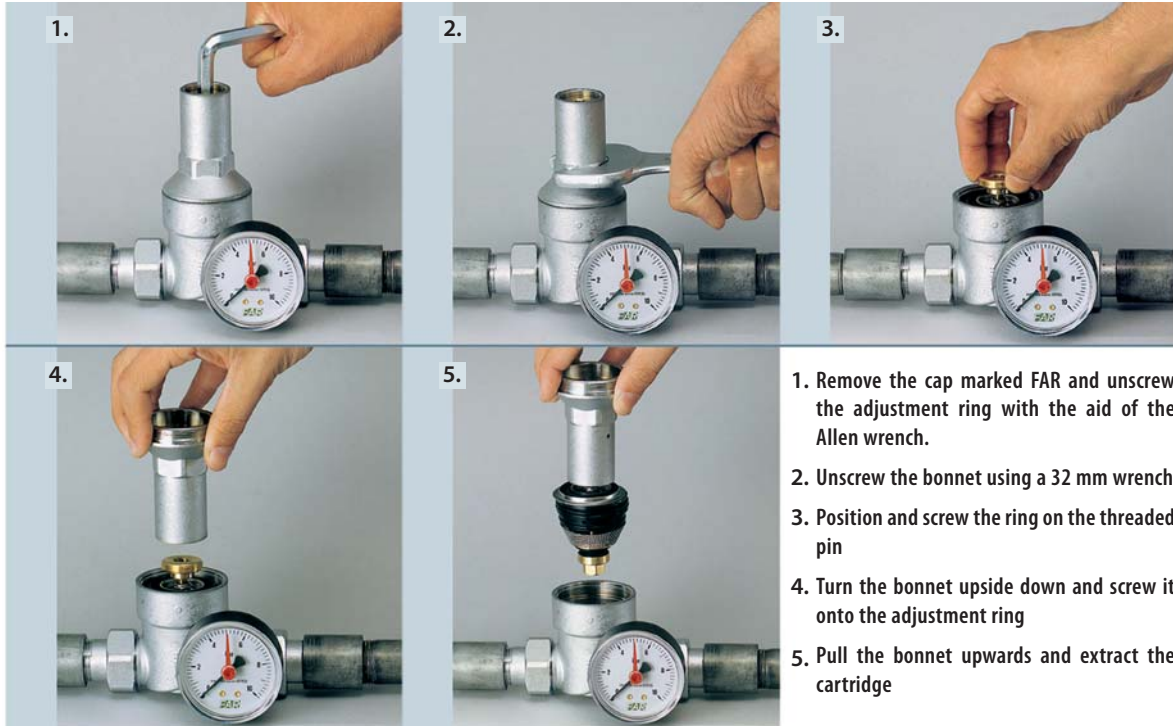

1. Remove the cap marked FAR and unscrew the adjustment ring with the aid of the Allen wrench.
2. Unscrew the bonnet using a 32 mm wrench
3. Position and screw the ring on the threaded pin
4. Turn the bonnet upside down and screw it onto the adjustment ring
5. Pull the bonnet upwards and extract the cartridge

Now check the filter - washing where required. Reassemble the cartridge - replacing if damaged - position the steel ring, the spring and screw on the bonnet. Then screw the ring and set the desired pressure value.

In order to extract the cartridge from a 1 1/2"-2" reducing valve, unscrewed the bonnet by means of a 42 mm wrench. Then remove the spring and the steel ring. Position two screwdrivers under the brass disc - as shown in the figure - and push down.

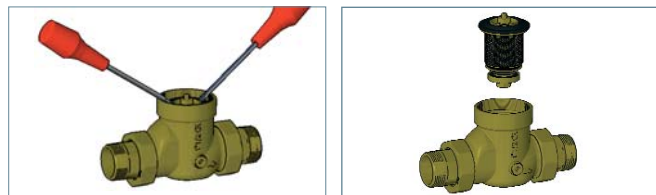

## 5. SELECTING THE RIGHT PRESSURE REDUCING VALVE

In order to choose the size of pressure reducing valve best suited to the specific installation requirements, refer to the flow rate / speed diagram. Bear in mind that in order to reduce noise in the pipes it is best to work with a water speed ranging from 1 to 2 m/s or compressed air between 10 and 20 m/s.

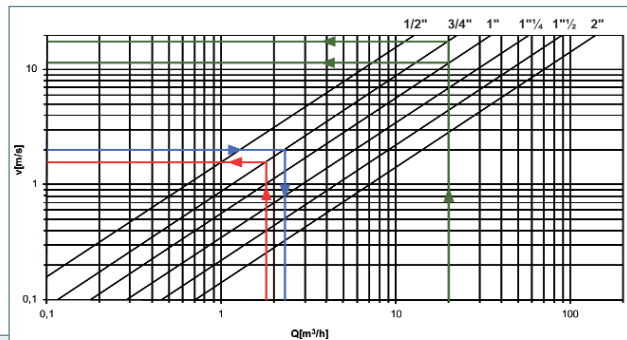

**Example 1 (red line)**  
Choosing a reducer for 30 l/min

**Solution**

The point corresponding to 30 l/min (1,8 m<sup>3</sup>/h) is on the abscissa. Move up vertically until you intersect the line corresponding to the diameter of the reducing valve ranging from 1 to 2 m/s. In this example we require a 3/4" pressure reducing valve.

**Example 2 (blue line)**

Check the flow rate of a 3/4" reducing valve operating at a speed of 2 m/s (i.e. at the suggested limit of application).

**Solution**

With 2 m/s on the ordinate, draw a line parallel to the abscissa until you intersect the 3/4" line. At that point, the flow rate reads a value of 2.2 m<sup>3</sup>/h (36.6 l/min).

**Example 3 (green line)**

Choosing a reducer for an air capacity of 20m<sup>3</sup>/h.

**Solution**

Extend from the required flow rate on the abscissa until you intersect the reducing valve curves. In this case there are 2 curves, giving us the choice between a 3/4" and a 1" unit.

## 6. AVAILABLE PRESSURE REDUCING VALVES

All FAR reducers are available in the following sizes: 1/2", 3/4", 1", 1 1/4", 1 1/2" and 2", and in brass or chrome-plated versions.



**ART. 2800 - ART. 2805 (COMPLETE WITH PRESSURE GAUGE)**  
Brass pressure reducing valve for domestic services and heating systems, with male-male connections



**ART. 2820 - ART. 2825 (COMPLETE WITH PRESSURE GAUGE)**  
Brass pressure reducing valve for domestic services and heating systems, with male-female connections



**ART. 2840 - ART. 2845 (COMPLETE WITH PRESSURE GAUGE)**  
Brass pressure reducing valve for domestic services and heating systems, with female-female connections



**ART. 2810 - ART. 2815 (COMPLETE WITH PRESSURE GAUGE)**  
Chrome-plated pressure reducing valve for domestic services and heating systems, with male-male connections



**ART. 2830 - ART. 2835 (COMPLETE WITH PRESSURE GAUGE)**  
Chrome-plated pressure reducing valve for domestic services and heating systems, with male-female connections



**ART. 2850 - ART. 2855 (COMPLETE WITH PRESSURE GAUGE)**  
Chrome-plated pressure reducing valve for domestic services and heating systems, with female-female connections

## 7. TECHNICAL FEATURES

<b>Reducer body material:</b>	CR brass (CB770S)
<b>Sealing seat:</b>	AISI303 Steel
<b>Cartridge material:</b>	CR brass (CW602N)
<b>O-ring and gaskets material:</b>	EPDM

<b>Adjustable downstream pressure:</b>	from 1 to 6 bar
<b>Nominal pressure:</b>	25 bar
<b>Max working temperature:</b>	30°C
<b>Compatible media:</b>	water and air

## 8. DIMENSIONAL FEATURES

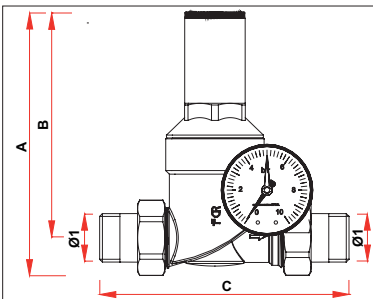

CODE	Ø1	A	B	C
2805 12	G1/2	137	121	140
2815 12	G1/2	137	121	140
2805 34	G3/4	142	121	152
2815 34	G3/4	142	121	152
2805 1	G1	185	158	170
2815 1	G1	185	158	170
2805 114	G1 1/4	190	158	188
2815 114	G1 1/4	190	158	188
2805 112	G1 1/2	198	161	208
2815 112	G1 1/2	198	161	208
2805 2	G2	201	161	228
2815 2	G2	201	161	228

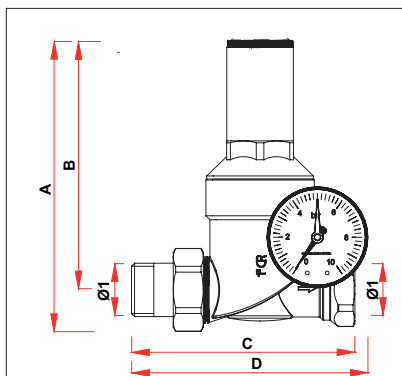

CODE	Ø1	A	B	C	D
2825 12	G1/2	137	121	115	127
2835 12	G1/2	137	121	115	127
2825 34	G3/4	142	121	126	130
2835 34	G3/4	142	121	126	130
2825 1	G1	185	158	140	155
2835 1	G1	185	158	140	155

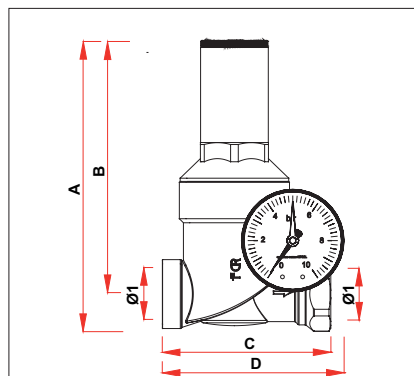

CODE	Ø1	A	B	C	D
2845 12	G1/2	136	121	87	97
2855 12	G1/2	136	121	87	97
2845 34	G3/4	137	121	95	101
2855 34	G3/4	137	121	95	101
2845 1	G1	180	158	104	113
2855 1	G1	180	158	104	113

## 9. PRESSURE REDUCING VALVE - COMPACT LINE

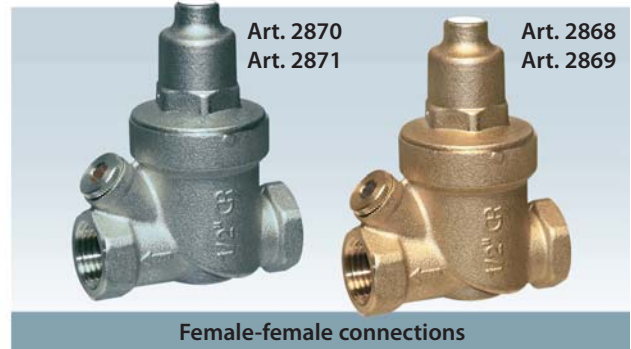

### 9.1 DESCRIPTION

The downstream pressure is kept constant by means of a membrane, which balances the opening force applied by the pressure calibration spring. When the pressure of the fluid stream on the membrane is equal to the force of the calibration spring, there is no flow through the reducing valve.

When the user turns on a tap, however, the water pressure acting on the membrane is reduced, allowing the spring to open and fluid to flow. The special shape of the cartridge and the internal profile of the cartridge ensure the fluid flows smoothly and quietly through the valve, without potentially damaging turbulence.

The stem seal inside the cartridge has been designed to operate with high upstream pressures. It comprises an O-ring toroidal gasket, enclosed between two Seger washers made of a special material with an anti-extrusion function. Connection for a pressure gauge is located near the outlet of pressure reducing valve. Development, design and testing of FAR pressure reducing valve are in compliance with EN1567:2002 Standards.

FAR reducing valves will automatically compensate for changing pressures in the system so that any sudden pressure surge in the water flow will not affect the setting. The variation limits of the downstream pressure will depend on any rise or reduction in the pressure upstream of the reducing valve. In other words, if water pressure rises by some degree, as normally occurs at night, the set pressure remains constant.

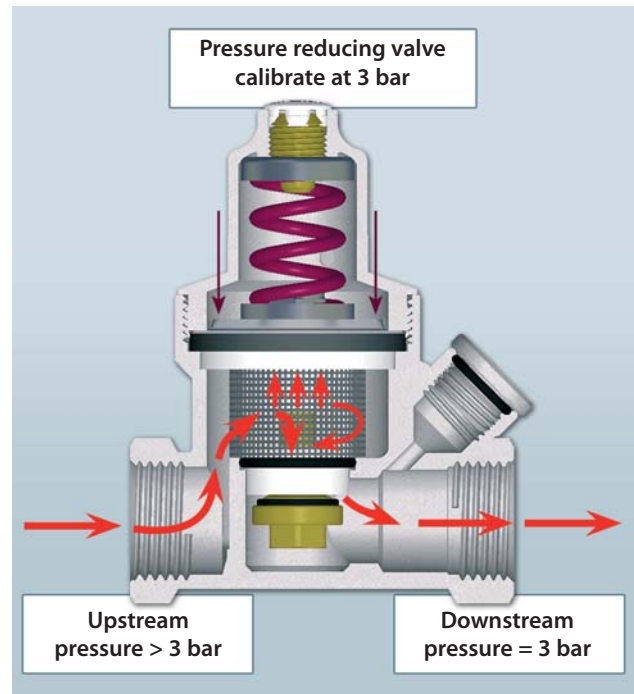

### 9.2 INSTALLATION

The pressure reducing valve is normally located between two shut off points, one downstream and one upstream. These are useful for downstream pressure calibration and for regular, periodic maintenance.

Calibration of the downstream pressure on the reducing valve is made by increasing or decreasing the compression of the spring located inside the cap in the upper part of the reducing valve. In order to set the pressure value, once the reducing valve is installed, it is essential to:

- Close the shut off valve downstream of the reducing valve
- Remove the protective plug by means of a screwdriver
- Using the Allen wrench supplied, screw the spring nut in a clockwise direction; the spring is thus compressed and the value of the calibrated pressure increases (unscrewing counter-clockwise causes both spring and calibration pressure to decrease)
- In order to make sure that calibration has taken place, it is recommended that the shut off valve downstream of the reducing valve be opened and closed - NB these operations must be carried out slowly, without risking damage to system components from water hammer.
- Now screw the protective cap back in position.

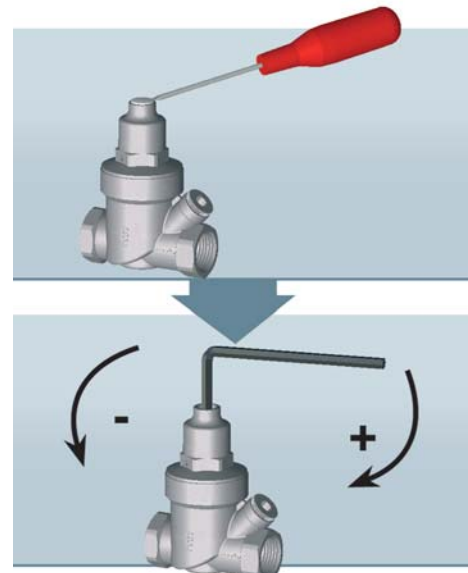

## Installation example

When installing a pressure reducing valve on a boiler connection, an expansion tank should be located between the two components in such a way as to absorb any pressure increase resulting from the boiler overheating the water. This is a potential problem because the pressure reducing valve - once in the closed position - does not allow venting of pressures generated in the next section of the system.

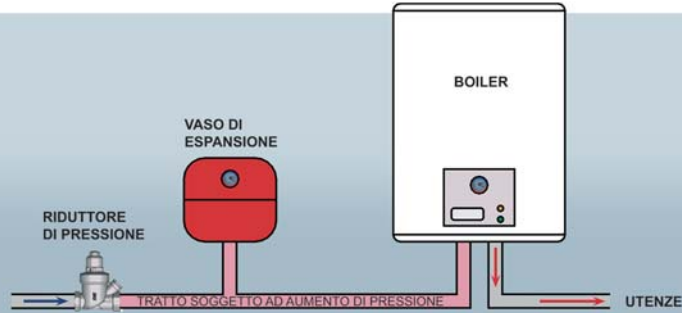

## 9.3 MAINTENANCE

Inside a pressure reducer, particles of calcareous substances, mineral salts, etc can pass through and deposit on the filter, which is incorporated into the cartridge inside the pressure reducing valve. Deposits formed in this way can decrease water flow, thus causing pressure flow problems and malfunction of the pressure reducer itself. Regular maintenance of the cartridge is important in order to avoid these problems. The pressure reducing valve has a system for extracting the internal cartridge without the need for special tools that might damage key components of the valve. Extraction of the cartridge can be carried out without disconnecting the reducing valve from the pipework; in order to do this first close the shut off valves located before and after the reducer and then:

1. Remove the closing cap by means of a screwdriver to access the spring regulating screw.
2. Turn the ring counterclockwise using a 5 mm Allen wrench to remove tension on the spring.
3. Unscrew the brass cap using a 25 mm wrench.
4. Remove the cartridge by positioning two screwdrivers under the metal disc - as shown in the figure - and pushing down.
5. Once the cartridge is extracted, clean the strainer and seating.

## 9.4 TECHNICAL AND DIMENSIONAL FEATURES

### Technical features

Reducer body material:	CR brass (CC752S)
Adjustable downstream pressure:	from 1 to 6 bar
Nominal pressure:	16 bar

Max working temperature:	30°C
Compatible media:	water and air
Calibrated at:	3 bar

### Dimensional features

CODE	Ø1	A	B	C	D
2868-2870 12	G1/2	91	77	68	-
2868-2870 34	G3/4	93	77	71	-
2869-2871 12	G1/2	91	77	68	113
2869-2871 34	G3/4	93	77	71	115

CODE	Ø1	A	B	C	D
2864-2866 12	G1/2	93	77	98	-
2864-2866 34	G3/4	96	77	102	-
2865-2867 12	G1/2	93	77	98	143
2865-2867 34	G3/4	96	77	102	146